

From Sarver, Pennsylvania,
Bob & Bernadette Dudeck's
1954 Champion Starliner & their 1964 R2 Avanti

BRAKE SECTION GLOSSARY

<i>Clutch & Pedal Related Parts</i>	256
<i>Parking Brake Related Parts</i>	256-257
<i>Calipers</i>	257
<i>Boosters & Related Parts</i>	258
<i>Self Adjuster Parts</i>	259
<i>Brake Drums & Related Parts</i>	260-261
<i>Disc Brakes & Related Parts</i>	262-263
<i>Wheel Cylinders & Related Parts</i>	263
<i>Master Cylinders & Related Parts</i>	264

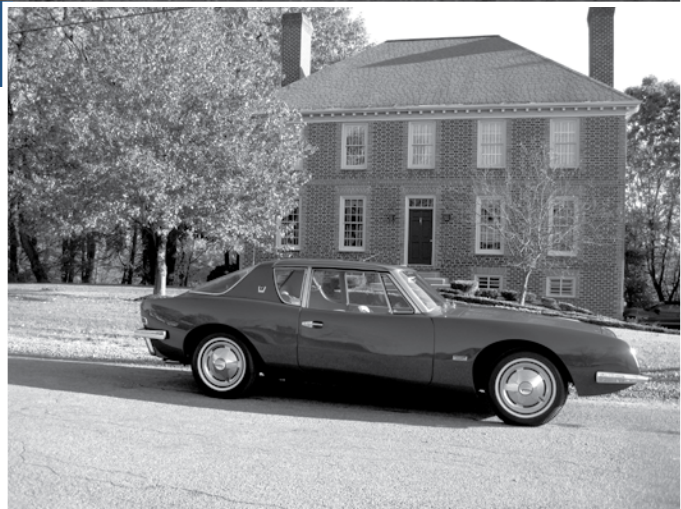

From Kennedale, Texas,
Michael & Aubrey Jone's 1963 R2 Avanti

BRAKE & CLUTCH PEDAL PADS

(Parts used on both drum & disc brake equipped vehicles.)

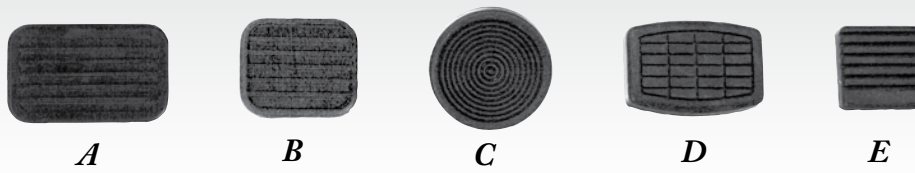

- (A) 536378** 1955-60 car, all models with automatic trans. 1961-64 Hawk with auto trans. **\$24.00 ea.**
(B) 537288 1955-60 car, all models with standard trans. 1961-64 Hawk with standard trans. **\$18.00 ea.**
(C) 675269 1939-46 Champion. 1941-42 Commander & President. 1947-54 car, all models with standard transmission. Truck: 1941-59 all models. 1960-64 C-cab. **\$15.00 ea.**
(D) 1552334 With standard transmissions, 1961-66 Lark and 1963-early Avanti II. Truck: 1963-64 Champ. **\$15.00 ea.**
(D) 1552335 1961-66 Lark, 1963-85 Avanti with automatic transmission. **\$20.00 ea.**
(E) 1562901 1964-66 Lark emergency brake. **\$12.00 ea.**

BRAKE & CLUTCH PEDAL SEALS

- 194562** 1939-46 Champion. 1941-42 Commander & President 1941-48 M-series truck. **\$2.00 ea.**
519635 1947-50 car, all models. **\$2.00 ea.**
530366 1951-58 car, all models. 1959-64 Hawk. **\$2.00 ea.**
678478 Truck: 1949-59 all models. **\$2.00 ea.**
1548523 1959-60 Lark. Truck: 1960-64 Champ. **\$2.00 ea.**
1689336 Truck: 3E, 4E, 5E, 6E 40, 7E, 8E 15, 25, 35, 40, 45. **\$2.00 ea.**

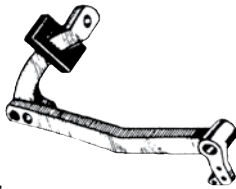

REAR PARKING BRAKE CABLES

- 519796** 1947-50 Commander. NOS **\$75.00 ea.**
519797 1947-49 Land Cruiser. NOS **\$39.80 ea.**
530181 1951-52 Land Cruiser. NOS **\$39.80 ea.**
533055 1953-58 sedan except Land Cruiser. NOS **\$62.50 ea.**
533065 1954-64 C & K includes Hawk & 1954-58 Land Cruiser 4-door plus President long wheel base 4 door sedan. **\$69.95 ea.**
535108 Adjusting rod. 1954-63 car, all models & 1964 Hawk. Truck: 7E, 8E 5, 7, 10, 12. **\$12.50 ea.**
NEW Listing - 674292 Truck: 2R, 3R, E 5, 6, 7. **\$84.00 ea.**
1547885 1959-62, 2-door Lark sedan & hardtop. 4-door Lark sedan. 1963-66 2-door sedan or hardtop. **\$75.00 ea.**
1547886 1959-66 Lark station wagon without sliding roof. 1964 Cruiser. 1962-66 4-door sedan. **\$75.00 ea.**
1549688 1960-64 convertible. **\$65.00 ea.**
1558235 1963-66 2-door Lark sedan & hardtop with front disc brakes. **\$72.00 ea.**
1558236 1963-66 4-door Lark & station wagon without sliding roof & with front disc. **\$72.00 ea.**
1558237 1963-64 Lark convertible & 1963-75 Avanti with front disc. **\$72.00 ea.**
1558238 1963-64 Hawk with front disc. **\$72.00 ea.**
1558239 1963-66 Wagonaire with sliding roof with front disc. **\$72.00 ea.**
1559954 1963-66 Wagonaire with sliding roof. **\$72.00 ea.**
1694783 Truck: 5E to 7E 122 models 10, 11, 12. 8E 122 models 5, 7, 10, 12. ... **\$72.00 ea.**

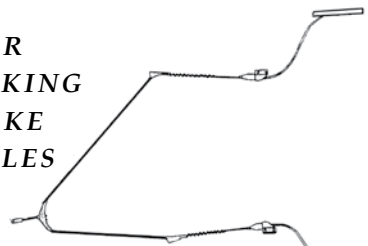

BRAKE & CLUTCH PEDAL BUSHINGS

- NEW Listing - 1543913** brake only, 1958-60 sedan includes Lark & 1958-64 Hawk. Takes 2. **\$4.50 ea.**
1543914 Clutch & brake, 1961-66 all models except C & K & 1963-85 Avanti. If your pedal wobbles, these probably need replacing. Takes 2. **\$3.50 ea.**



PARKING BRAKE CABLE GUIDE

- 532669** Left rear. 1953-66 all models except convertible & 1963-66 Wagonaire. Right rear. 1960-64 convertible, 1963-66 Wagonaire & 1963-85 Avanti. **\$16.00 ea.**
1549483 Left rear. 1960-64 convertible, 1963-66 Wagonaire & 1963-85 Avanti. **\$16.00 ea.**



FRONT PARKING BRAKE CABLES & SPRINGS

- 519844** Cable only. 1947-49 Champion & Commander. NOS. **\$20.00 ea.**
NEW Listing - 520397 Front emergency brake anchor spring. 1947-50 all except automatic transmission. **\$9.00 ea.**
526387 Cable only. 1950 Champion. NOS. **\$46.50 ea.**
526388 Cable only. 1950 Commander & Land Cruiser. NOS. **\$46.50 ea.**
NEW Listing - 530083 Front emergency brake anchor spring. 1950 Champion with automatic transmission. **\$12.50 ea.**
530616 Cable only. All 1951-52 car. **\$25.00 ea.**
NEW Listing - 530128 Front emergency brake anchor spring. 1951-52, all. **\$12.50 ea.**
533020 Cable only. 1953 sedan. **\$29.00 ea.**
537719 Cable only. 1955 sedan with wraparound windshield. 1956-58 sedan & 1958-64 Hawk **\$85.00 ea.**
1547905 Cable only. 1959-60 Lark except convertible & 1954-57 C & K. **\$80.00 ea.**
1554476 Cable only. 1962-63 Lark except convertible. **\$65.00 ea.**
1554477 Cable only. 1962-63 convertible, 1963-71 Avanti & 1963 Wagonaire **\$75.00 ea.**
1692256 Cable only. Truck: 1960-64 Champ. **\$80.00 ea.**

FRONT PARKING BRAKE PARTS

- 1701186** Center parking brake handle seal. 1976-85 Avanti. **\$6.50 ea.**
523222 Spring with clamp. All 1947 car & early 1948 convertible. **\$8.50 ea.**
523966 Tube with spring and bracket. All 1947 car & early 1948 convertible. **\$26.00 ea.**
525621 Complete front handbrake assembly. All 1949 car. **\$48.50 ea.**
525627 Handle & plunger. All 1949 car & some 1950 car. **\$28.00 ea.**

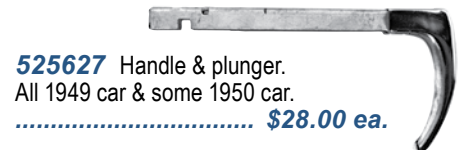
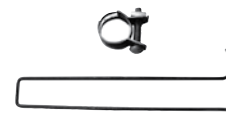

525634 Cable & ends. All 1949 car.
.....**\$16.50 ea.**



527640 Guide & pawl kit. 1950 car. Refer to Chassis parts book.
.....**\$39.80 ea.**



530612 Rod & button. 1951-54 car.
.....**\$16.50 ea.**

530743 Handle & plunger. All 1951-52 car.
.....**\$24.00 ea.**



532972 Complete assembly. 1953 sedan.
.....**\$75.00 ea.**

533014P Guide. 1954 sedan. . **\$28.50 ea.**



533015P Guide. 1958 C & K. . **\$28.50 ea.**

533019 Handle & plunger. 1953 car.
.....**\$20.00 ea.**

535321 Guide. 1954 Champion & 1955-57 sedan.
.....**\$28.50 ea.**



NEW Listing - 535324

Latch, pawl. Holds plunger when extended. 1954-63, all models; 1964 Hawk & 1963-76 Avanti.

Truck: 1960-64 Champ.**\$12.50 ea.**

535325 Handle spring. Holds handle in place when engaged. 1955-63, all models; 1964 Hawk & 1963-76 Avanti with hand parking brake. If your handle won't stay out when pulled, this spring needs to be replaced. ... **\$3.50 ea.**



535513 Handle & plunger. All 1954 Champion including C & K; 1954 Champion sedan & all 1955 except with curved windshield. **\$28.50 ea.**

535514 Handle & plunger. 1954 Commander C&K, 1955 sedan with curved windshield & all 1956-58 models.. **\$28.50 ea.**

684785 Retainer clip. Lever arm to rear shoe 1963-64 Hawk, 1963-66 Lark & 1963-75 Avanti with front disc. Truck: E-2E 5, 6, 7 & 3E-6E 1, 2, 3, 5, 6, 7 & 7E 5, 7 **\$2.00 ea.**



1546335 Spring, cable pull back. 1958-63 car, all models; 1964 Hawk & 1963-85 Avanti. **\$8.95 ea.**



1548302 Pin, parking brake handle. 1959-63 Lark, 1959-63 Hawk, 1963-83 Avanti
.....**\$4.50 ea.**

NEW Listing - 1551997 bulb, flashing, brake warning light, 12-volt. **\$3.50 ea.**

1554483 Handle & pin. 1959-63 all Lark, 1959-61 Hawk & 1963-1976 Avanti with hand parking brake.**\$16.00 ea.**



NEW Listing - 1555606

handle & plunger, 1959-63 Lark. Truck: 1960-64 Champ.
..... **\$36.50 ea.**



1563632 Release handle. 1964-66 Lark..**\$10.00 ea.**

1564311 Plastic grommet, release rod. 1964-66 Lark. **\$3.95 ea.**

SILICONE BRAKE FLUID



800395 Dot 5, 12 oz.
.....**\$12.90 ea.**

BRAKE PARTS CLEANER



800943 Cleans oil & grease from linings, drums, etc. 20 oz. aerosol.....**\$5.25 ea.**

FRONT CALIPER



1558182 1963-64 Hawk, 1963-66 Lark, 1963-83 Avanti. New & completely assembled with seals and piston. Takes 4. **\$110.00 ea.**

FRONT CALIPER PARTS

FOR 1963-66 LARK, 1963-64 HAWK & 1963-83 AVANTI WITH FRONT DISC

- G145637** Ball, under bleeder screw. **\$1.00 ea.**
- 1557504** Bracket, right caliper mounting. **\$65.00 ea.**
- 1557505** Bracket, left caliper mounting. **\$65.00 ea.**
- 1557510** Caliper shim .010* **\$1.50 ea.**
- 1557511** Caliper shim .013* **\$1.50 ea.**
- 1557512** Caliper shim .016* **\$1.50 ea.**
- 1557513** Caliper shim .019* **\$1.50 ea.**

*NOTE: FOR PROPER BRAKING, DISC BRAKE CALIPERS MUST BE ALIGNED USING SHIMS. FOLLOW INSTRUCTIONS IN YOUR STUDEBAKER SHOP MANUAL.

DISC BRAKE CALIPER REPAIR KIT

1558063 1963-64 Hawk, 1963-66 Lark, 1963-83 Avanti. Seals for 4 calipers. Enough for two wheels.
..... **\$68.00 ea.**



HAND OR PARKING BRAKE 1950 Car

Models 9G - 17A. Used on cars with Standard & Overdrive.

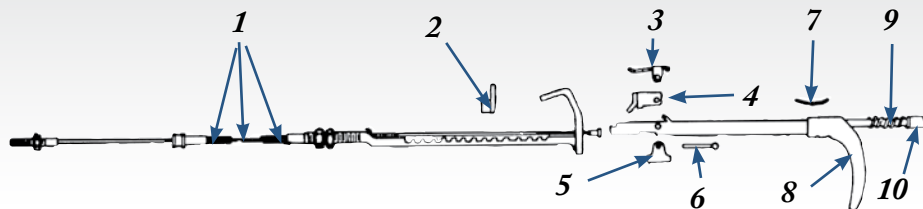

- (1) 526387** Front parking brake cable. 1950 Champion **\$46.50 ea.**
- (1) 526388** Front parking brake cable. 1950 Commander & Land Cruiser. **\$46.50 ea.**
- (2) 525625** Anti-rattle spring. **\$3.50 ea.**
- (3) 525638** Spring, hand brake control plunger pawl..... **\$4.50 ea.**
- (4) 527638** Pawl, all **\$8.50 ea.**
- (5) 525639** Stop, all **\$2.50 ea.**
- (6) 525480** Rivet, all..... **\$1.00 ea.**
- (7) 526995** Spring, anti-rattle. **\$2.50 ea.**
- (8) 527011** Handle & plunger... **\$36.50 ea.**
- (9) 525633** Spring, release..... **\$2.50 ea.**
- (10) 525630** Rod & button. **\$20.00 ea.**

801818 Parking brake handle kit. Includes all parts #1-10 for 1950 Champion.

Total of all parts if purchased separately **\$128.00**

Special package price \$115.00

801819 Parking brake handle kit. Includes all parts #1-10 for 1950 Commander & Land Cruiser.

Special package price \$115.00

BRAKE BOOSTER/ HYDROVAC REPAIR KITS & RELATED PARTS

NEW Listing - 536985 Hydrovac check valve. 1955-64 car except 1957-58 Golden and Packard Hawk with air conditioning and 1963-64 Hawk with disc brakes. **\$36.00 ea.**

NEW Listing - 537239 Control valve repair kit. 1955-64 car with Hydrovac. Truck: 3E through 8E models 10, 11, 12, 13, 14, 15. **\$25.00 ea.**

NEW Listing - 537933 Hydrovac repair kit. 1955-56 cars with model # 377478 Hydrovac. **\$95.00 ea.**

NEW Listing - 677442 Diaphragm for Hydrovac. 1955-56 car with Hydrovac #377148 or 377478. Limited quantities. **\$40.00 ea.**

NEW Listing - 677614 Control valve repair kit. All 2R through 8E 16, 17, 28, 35, 38, 38, 40, and 45 except 40 & 45 with heavy duty brakes. **\$25.00 ea.**

NEW Listing - 679690 Major Midland Hy-Power booster repair kit. 2R 16 & 17 Model trucks equipped with the Midland booster. **\$95.00 ea.**

NEW Listing - 1541844 Hydrovac repair kit. 1955 cars with model # 377148 Hydrovac. **\$100.00 ea.**

NEW Listing - 1541845 Booster repair kit. 1959-60 car with booster model #376500. Truck: 3E through 8E 3/4 ton truck. **\$100.00 ea.**

NEW Listing - 1541846 Hydrovac repair kit. 1956-64 cars with model # 378003 Hydrovac. **\$100.00 ea.**

NEW Listing - 1553343 Booster repair kit. All 1961 Lark & 1962 Lark with type "B" booster. See 1959-64 chassis manual for illustration. **\$95.00 ea.**

1555590 Booster check valve seal. 1963-71 Avanti. 1963-66 Lark with disc brakes. **\$2.50 ea.**

NEW Listing - 1555595 Booster repair kit. All 1962 Lark & all 1959-64 Lark with type "C" booster. See 1959-64 chassis manual for illustration. **\$95.00 ea.**



1559721 Brake booster check valve. 1963-71 Avanti. 1963-66 Lark with disc brakes. Limited supply. **\$75.00 ea.**

NEW Listing - 1559735 Booster piston packing kit. All 1963-64 Hawks with disc brakes. Limited supply. **\$65.00 ea.**

1688220 Hydrovac repair kit for 6-3/4" diameter booster. All 2R-8E 16, 17, 28, 35, 38 trucks with overdrive. **\$95.00 ea.**

NEW Listing - 1688221 Hydrovac repair kit for 9-1/2" diameter booster. Truck: E & 2E 16, 17, 28, 38, 45 through 8E 16 through 35 with heavy duty brakes and 3E-8E 17, 38, 40, 45 with standard brakes. **\$95.00 ea.**

NEW Listing - 1689299 Complete Hydrovac repair kit. Truck: 3E-6E 1, 2, 3, 5, 6, 7, 7E-8E 5, 7. **\$85.00 ea.**

NEW Listing - 1691965 Control valve repair kit. Truck: 4E-8E models 40 through 45 with heavy duty brakes. **\$50.00 ea.**

NEW Listing - 1696523 Complete Hydrovac repair kit. Truck: 8E 25, 28, 35. **\$85.00 ea.**

Power Brake Boosters

Rebuilt boosters sold exchange only.
We must have your old core first.
When ordering please specify year & model of car. Send ONLY the bare core!
Remove brackets, fittings, etc.
There is an additional charge for disassembling cores.

Note: New boosters do not require a core first but if you should want to sell it, we will pay you \$50 for your rebuildable core.

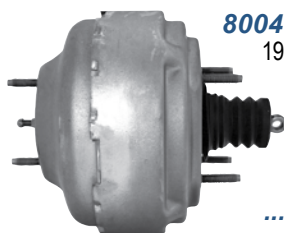

800490R

1971-85 Avanti.
Rebuilt

Does not include check valve.

..... **\$245.00 Ex.**

1544394R Hydrovac. 1955-60 car, all models. 1961-64 Hawk with drum brakes. Rebuilt. Does not include check valve. **\$280.00 Ex.**

802100

New manufacture Hydrovac 1955-60 car, all models. 1961-64 Hawk with drum brakes. **\$390.00 ea.**

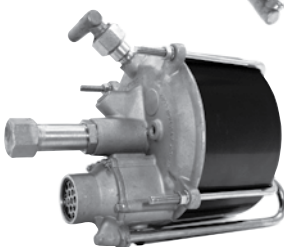

802101 New manufacture Hydrovac 1963-64 Hawk with front disc. **\$405.00* ea.**

1557903R

1963-66 Lark & 1963-71 Avanti with front disc. Rebuilt. Does not include check valve. **\$195.00 Ex.**

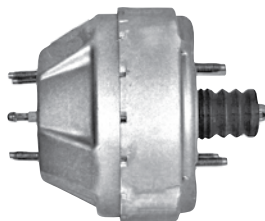

1558380R 1963-64 Hawk with front disc. Rebuilt. Does not include check valve. **\$295.00 Ex.**

New!



NEW Listing - 1559719 Booster. 1963 Lark with drum brakes. NOS. **\$325.00 ea.**

Note: Brake boosters for 1961-66 Lark. Call for availability & price: 317-462-3124 We need cores for all types of boosters! If you have any extra cores, we are always interested in purchasing them.

BOOSTER SEAL KITS

801123 Power brake booster rebuild seal kit. 1963-66 Lark. 1963-71 Avanti with front disc brakes. **\$140.00/kit**
801851 Seal Kit for Hydrovac, 1955-64 all models. **\$115.00/kit**

HYDROVAC FLEX HOSE

NOTE: These lines connect the front pipes to the Hydrovac and after many years of use acquire a build-up of residue that restricts the flow of fluid. If your brakes are sluggish, you may want to replace these 2 hoses.

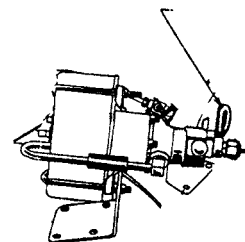

536652 1955-60 car & 1961-64 Hawk, all models with power assist. Truck: late 56-62 1/2 ton 2E, 7E. Takes 2. **\$32.50 ea.**



**Takes 2 for front
& 1 for rear**

FLEXIBLE HOSES

NOTE: ORIGINAL BRAKE HOSES USUALLY LOOK GOOD ON THE OUTSIDE BUT CAN BE BRITTLE AND HAVE A BUILD-UP OF RESIDUE INSIDE.

THE OLD RUBBER CAN ALSO PULL OFF OF THE METAL ENDS UNDER HEAVY PRESSURE.

BE SAFE — REPLACE THE HOSES!

185015 1935-38 Dictator, Commander & President front & rear. Truck: M15-M17 & 2R-8E 13-40 front & rear. **\$33.40 ea.**

195568 1939-41 Commander & President front & rear. 1941 Coupe Express front & rear. 1942 Commander & President rear. Truck: 1941-48 M-5 front & rear. **\$28.10 ea.**

519637 1947-49 car, all models front & rear. 1959-66 car, all models front. **\$28.10 ea.**

523614 1951-58 car, all models front. Truck: 2R-7E 1, 3, 5, 7, 10, 12 front & rear & 8E 5, 7, 10, 12 rear. **\$28.10 ea.**

526184 1939-46 & 1950-52 Champion front & rear. 1950-52 Commander front. Truck: 8E 5, 7, front. 3E-4E w/4WD front. **\$28.10 ea.**

1543003 1950-52 Commander rear. 1953-66 car, all models rear. 1963-85 Avanti, rear. Truck: 8E 10, 12 front. **\$28.10 ea.**

1557543 1963-64 Hawk, 1963-66 Lark, 1963-83 Avanti with front disc brakes. Takes 2. **\$28.10 ea.**

Self Adjuster Parts

1947-53

1963-66

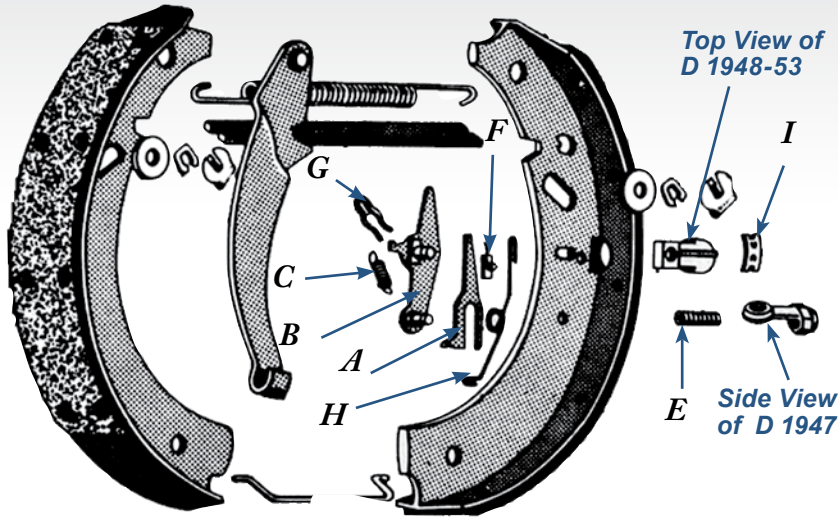

(For Non-disc brake cars only)

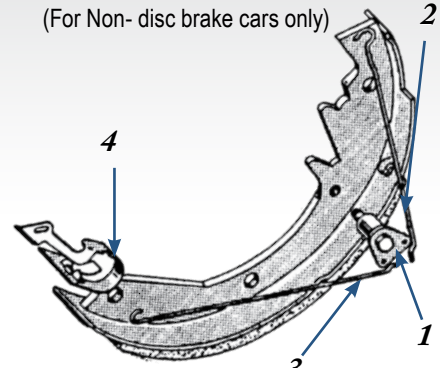

- (A) 521391 Right, wedge. All. ...\$7.50 ea.
- (A) 521392 Left wedge. All.\$7.50 ea.
- (B) 521393 Right lever. All.\$17.50 ea.
- (B) 521394 Left lever. All.\$17.50 ea.
- (C) 521395 Spring. All.\$3.50 ea.
- (D) 521396 Self-adjuster tip. Enough for 2 wheels.\$6.50/pr.

801277 16 piece kit for front or rear. 1947 car only. Takes 2 kits per car.\$89.00/kit

- (E) 521397 Spring. 1947 only. . \$3.00 ea.
- (F) 521398 Guide. All.\$5.50 ea.
- (G) 521572 Cotter. 1947 only.\$1.00 ea.
- (H) 524028 Right spring. 1948-53.\$4.50 ea.
- (H) 524029 Left spring, 1948-53. . \$4.50 ea.
- (I) 527253 Spring. All.\$5.50 ea.

801278 14 piece kit for front or rear, 1948-53 car, all models 1949-53, 1/2 ton truck. Takes 2 kits per car.\$84.00/kit

- (1) 1558502 Right, screw & lever.\$7.50 ea.
- (1) 1558503 Left, screw & lever.\$7.50 ea.
- (4) 1558508 Right, adjusting lever.\$17.50 ea.
- (4) 1558509 Left, adjusting lever.\$17.50 ea.
- (2) 1558510 Adjusting link anchor, front for 6-cylinder, rear for V-8.\$2.25 ea.
- (3) 1558511 Adjusting link anchor actuating, front for 6-cylinder, rear for V-8.No Stock
- (2) 1558516 Rear, adjusting link anchor. 6-cylinder.\$2.25 ea.
- (3) 1558517 Rear, adjusting link anchor actuating for 6-cylinder.\$2.25 ea.
- (2) 1558526 Front, adjusting link anchor. V-8.\$2.25 ea.
- (3) 1558527 Front, adjusting link anchor actuating. V-8.\$2.25 ea.

BRAKE HOSE COPPER WASHERS & LOCK CLIPS

- 185166 Washer, 1935-42 Dictator, Commander, Coupe Express. Truck: M5-M17 & 2R-8E 13-45.\$1.00 ea.
- 195569 Washer, 1939-46 Champion. 1947-66 car, all models. Truck: 2R-8E 1, 2, 3, 5, 6, 7, 10, 11, 12.\$1.00 ea.

- 675466 Lock clips, brake hose to frame. 1947-66, all.\$1.50 ea.

FIREWALL BOOT

- 1553241 1961-66 Lark & 1963-85 Avanti.\$6.00 ea.



HILL HOLDER VALVE SEAL KITS

- 526633 1950-66 car, all models, 1963-64 Avanti. Truck: 1941-63 all models. Includes cam plug gasket, rubber washer, & head chamber gasket.\$22.00 ea.
- 526633X1 Same as above except ball cage included.\$95.00 ea.
- 801704 Ball only.\$3.65 ea.

Returning Parts?

Don't forget a copy of your invoice with your return

There is a \$5.00 "Invoice Search" fee for items returned without an invoice



ADJUSTING SCREW, NUT & GUIDE

- 535164 1954-62 car, all models. Truck: 8E 5, 7.\$9.00 ea.
- 1558504 Right. 1963-66 car, all models. Non-disc brake car only.\$13.75 ea.
- 1558505 Left. 1963-66 car, all models. Non-disc brake car only.\$13.75 ea.



ADJUSTING HOLE PLUG

- 535168 1954-66 car, all drum brake models. Non-disc brake car only. Takes 4.\$1.50 ea.



BRAKE LINE JUNCTION BLOCK "T" FITTING

- 194697 "T" fitting on rear axle. 1939-46 Champion, 1947-66 car & 1963-71 Avanti. Truck: 2R-6E 5, 6, 7, 10, 11, 12 & 3E-6E 1, 3 & 7E-8E 5, 7, 10, 12.\$14.95 ea.





CARS

194525 Right, front drum & hub. 1939-40 Champion. **\$150.00 ea.**

194526 Left, front drum & hub. 1939-40 Champion. **\$150.00 ea.**

194649 Drum only, front or rear. 1939-46 Champion. **\$140.00 ea.**

513147 Right, front drum & hub. 1941-46 Champion. **\$140.00 ea.**

520344 Front drum or Rear drum. 1947-50 Champion. **\$197.50 ea.**

524164 Front drum & hub assembly. Right side on late 1948 - 1950 Champion. This can also be used on the left side by also purchasing 4 - 196308 nuts. **\$224.50 ea.**

529118 Drum & hub, right front. 1951-53 Commander. **\$195.00 ea.**

529119 Drum & hub, left front. 1951-53 Commander. **\$195.00 ea.**

535524 Front, drum only. 1954-56 6-cylinder. **\$197.50 ea.**

1539469 Front left. 1956 Champion 6-cylinder. All with left hand thread. **\$224.50 ea.**

1542151 10" Front left, drum & hub. 1957-58 6 cylinder. All with left hand thread. **\$224.50 ea.**

1542157 10" Front drum. 1956-62 6 cylinder. Rear drum for 1956-64 V-8. **\$197.50 ea.**

1557400 Rear drum, 11" finned complete with hub & studs. All 1963-66 Lark and Hawk with front disc. 1963-64 Avanti with tapered axles. Pictured. **\$199.95 ea.**

1558894 Front, drum & hub. 1963 6-cylinder. Should fit 1956-66 6-cylinder. **\$224.50 ea.**

1558903 11" Front, drum only with 3 1/8" diameter mounting hole. 1963-64 V-8. **\$197.50 ea.**

1558905 10" Rear finned, drum only. 1956-66 V-8 with tapered axle. Includes studs. **\$159.95 ea.**

1561790 10" Rear, drum only. 1966 6-cylinder & V-8 car with flanged axle. Considered heavy duty on 6-cylinder only. **\$149.95 ea.**

1561791 10" Rear drum, finned. 1965-66 cars with flanged axles. Will not fit tapered rear axle. **\$149.95 ea.**

1562455 10" Front, drum & hub. 1964-66 6-cylinder. Should fit all 6-cylinder back through 1956. Right-hand thread. **\$227.50 ea.**

1562457 Front drum with right-hand thread, 11" finned. Complete with hub & cups. 1956-66 V-8. **\$199.95 ea.**

Available Fall 2014 - 1697013 Drum only, front and rear. 1940-50 Commander & Land Cruiser. Includes 5 new studs. **\$195.00 ea.**

Brake Drums

TRUCKS (Note: All are available in extremely limited quantities.)

676026 Rear drum only. M16, M17, 2R through 6E models 16, 17, 28, 38, 1941-1961. Also fits 7E & 8E models 25 & 28 1962-64 all with 4" wide rear brakes. **\$327.50 ea**

677863 Rear hub & drum, left side on all 2R through early 2E (1949-56) 3/4-ton truck models 10, 11, 12. **287.50 ea**

1686176 Front drum. 1957-64 3E through 8E model 40 with standard front axle. Also fits 1962-64 models 45 with the same equipment. All less air brakes. **\$278.50 ea**

1689286 Front hub & drum. 1957-59 3E through 8E 3/4-ton models 10,11, 12. with heavy duty front axle. **\$387.50 ea.**

1690121 Rear hub & drum for 1957-64 3E through 8E Truck model 40 with heavy duty rear axle and less air brakes. Also fits 1962-64 model 45 with the same equipment. **\$327.50 ea.**

1691108 Front, drum only. 1962-64 7E & 8E 40 & 45 models with heavy duty front axle and less air brakes. Also having the forging number embossed on the front I-beam itself. Note: This drum is standard equipment for 40E & 45E and optional on 40A & 45A. **\$327.50 ea.**

1694897 Front (drum only), 1962-64 7E & 8E 40 & 45 models with heavy duty front axle disc. Equipped and with air brakes. Also having the forging number embossed on the front I-Beam itself. **\$327.50 ea.**

1694984 Front (drum only), 1962-64 7E & 8E 40 & 45 models with heavy duty front axle having Gunite wheels, air brakes, and also having the forging number embossed on the front I-Beam itself. **\$327.50 ea.**

1694991 Rear (drum only), 1962 7E 40 & 45 models with heavy duty rear axle having Gunite wheels, air brakes, and axle ID plate stamped H-140-PX32 or H-340-PX20. **\$327.50 ea.**

NEW Listing - 1697013 drum only, front and rear. 1941-64 1/2 ton truck. Includes 5 new studs. **\$195.00 ea.**

BRAKE DRUM PULLER

AVAILABLE FALL 2014



J-1644 Rear brake drum puller for all models with tapered rear axle. **\$225.00 ea.**

SPRINGS



159238 Shoe return spring. 1931 President. **\$10.50 ea.**

159239 Shoe return spring. 1931 President. **\$10.50 ea.**

159243 Shoe return spring. 1931 President. **\$10.50 ea.**

185480 Shoe return spring. 1935-37 Dictator. 1935-40 President. 1935-40 Commander. Takes 4. Truck: 1941-48 M5 front. **\$8.00 ea.**

193129 Shoe return spring. 1938-40 Commander & President. **\$9.50 ea.**

199992 Shoe return spring. 1941-42 Commander & President rear. Truck: 1941-48 M5 rear. **\$8.00 ea.**

521407 Shoe return spring. 1947-53 Champion front & rear 1951-53 Commander rear. **\$8.00 ea.**

521567 Shoe return spring. 1947-50 Commander front & rear. 1951-53 Commander front. Truck: 2R-3R 5, 6, 7. **\$8.00 ea.**

530867 Pedal pull-back spring. 1951-53 car with auto trans **\$7.00 ea.**

535157 Anti-rattle spring for rear brake shoe operating link. 1954-66 car, all models. Takes 2 per car. **\$4.50 ea.**



535160 Shoe return spring. 1954-66 car, all models. Takes 2 per wheel. **\$3.50 ea.**

535167 Adjusting screw spring. 1954-62 car, all models. Takes 1 per wheel. Truck: 8E 5, 7 **\$3.75 ea.**

535189 Pedal pull-back spring. 1954-60 car, all models without power assist. 1961-64 Hawk without power assist. **\$7.50 ea.**

536622 Pedal pull-back spring. 1954-60 car, all models with power assist. 1961-64 Hawk with power assist. **\$7.00 ea.**

666131 Front shoe return spring. Truck: 2R, 16, 17. **\$7.95 ea.**

683043 Shoe return spring. Truck: 2E 10, 11, 12 & 3E-6E 13, 14 & 7E-8E 13, 15. **\$9.50 ea.**

800794 Shoe return spring kit. Truck: late 1956 (2E) through 1962 1/2 ton. Car: 1963-64 Hawk, 1963-66 Lark, 1963 - early 1971 Avanti upper & lower. Enough for 2 wheels. Rear with front disc brakes only. **\$16.50 kit**

1552044 Pedal return spring. 1961-66 Lark **\$10.50 ea.**

1558507 Rear adjusting screw spring. 1963-66 without disc. **\$6.75 ea.**



1552044 Pedal return spring. 1961-66 Lark **\$10.50 ea.**

1558507 Rear adjusting screw spring. 1963-66 without disc. **\$6.75 ea.**

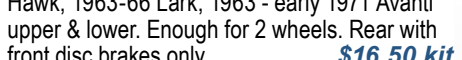

Special Drum Brake Rebuild Kits for 1947-62 Car & 1963-64 Hawk

1947-49 CHAMPION**

Total of all parts if purchased separately \$593.30
 Special kit price \$565.00
 — 10% QUANTITY DISCOUNT. SEE PAGE 4.
 \$56.50
801131R Your cost..... \$508.50/kit

1950-53 CHAMPION**

Total of all parts if purchased separately \$631.30 ea.
 Special kit price \$599.00
 — 10% QUANTITY DISCOUNT. SEE PAGE 4.
 \$59.90
801132R Your cost..... \$539.10/kit

1950 COMMANDER**

Total of all parts if purchased separately \$762.10
 Special kit price \$725.00
 — 10% QUANTITY DISCOUNT. SEE PAGE 4.
 \$72.50
801133R Your cost..... \$652.50 ea.

1951-53 COMMANDER**

Total of all parts if purchased separately \$712.80
 Special kit price \$678.00
 — 10% QUANTITY DISCOUNT. SEE PAGE 4.
 \$67.80
801134R Your cost..... \$610.20/kit

1954-60 6-CYL. CAR All models

Total of all parts if purchased separately \$534.30
 Special kit price \$508.00
 — 10% QUANTITY DISCOUNT. SEE PAGE 4.
 \$50.80
801035R Your cost \$457.20/kit

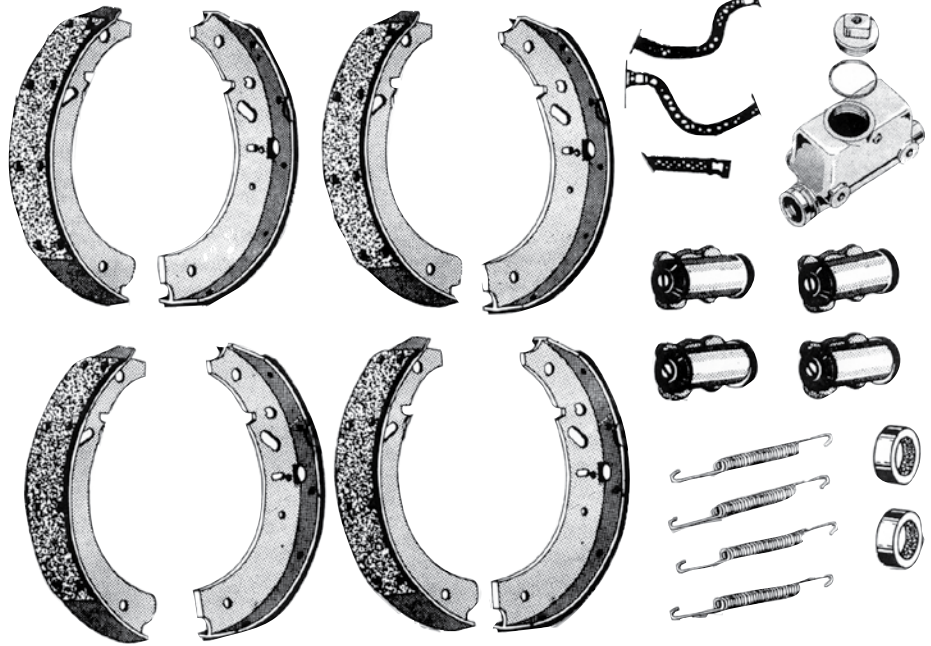

Kit includes

- | | |
|--|---|
| <p>1 Set of relined rear shoes
 Either applies, \$100.00 core charge, mandatory pre-order core send, first. or none of the above. See relined shoes on page 264 for further explanation.</p> <p>1 Set of shoe return springs
 Enough for all 4 wheels</p> <p>1 New master cylinder</p> <p>2 New front wheel cylinders</p> <p>2 New rear wheel cylinders</p> <p>2 Front bearing grease seals</p> <p>2 Flexible front hoses</p> | <p>1 Flexible rear hose</p> <p>3 Copper washers
 Flex hose to wheel cylinder</p> <p>4 Adjusting hole plugs
 1954 & Later only</p> <p>2 Pr. Self-adjuster tips
 1947-53 only</p> <p>1 Set relined front shoes
 Either applies, \$100.00 core charge, mandatory pre-order core send, first. or none of the above. See relined shoes on page 264 for further explanation.</p> |
|--|---|

****Note: All 1947 - 53 Cars require you to send your old shoes to us first**

*** These kits come with new shoes and do not require a core charge or your old shoes to be returned first.**

Please note: We reserve the right to change core charges and pre-send policies according to the availability of usable shoes to reline.

1954-60 V-8 CAR *

All models & 1961-64 Hawk

Total of all parts if purchased separately \$571.30
 Special kit price \$542.00
 — 10% QUANTITY DISCOUNT. SEE PAGE 4.
 \$54.20
801036R Your cost \$487.80/kit

1961-62 LARK 6-CYL.

Without power assist

Total of all parts if purchased separately \$568.90
 Special kit price 541.00
 — 10% QUANTITY DISCOUNT. SEE PAGE 4.
 \$54.10
801037R Your cost..... \$486.90/kit

1961-62 LARK V-8 *

Without power assist

Total of all parts if purchased separately \$605.90
 Special kit price \$578.00
 — 10% QUANTITY DISCOUNT. SEE PAGE 4.
 \$57.80
801038R Your cost \$520.20/kit

NOTE: When ordering specify year and model of car. No substitutions or deletions. Core charges are not discountable. Invoice must be included with core for refund.

(317) 462-3124 * FAX (317) 462-8891

Disc BRAKE ROTOR



1557500

Disc brake rotor 1963-66 all models & 1963-83 Avanti with front disc brakes including Avanti. Includes rotor, hub, stud and cups. Assembled and ready to install.....**\$199.95 ea.**

FRONT DISC BRAKE PADS

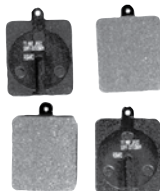

1558066

1963-64 Hawk, 1963-66 Lark, 1963-83 Avanti.**\$35.00 set/4**

SHOE ADJUSTMENT ECCENTRIC (INCLUDING NUT)



800908

Cars; 1963-64 Hawk, 1963-66 Lark, 1963-early 1971 Avanti, all with front disc brakes.

Truck; late 56-62 1/2 ton. (Disc Brake Cars - Takes 4. Trucks take 8).**\$24.00 ea.**

DISC BRAKE PIPES

1557546 Front hose to caliper. Right. 1963-64 Hawk, 1963-66 Lark, 1963-83 Avanti**\$20.00 ea.**



1557547 Front hose to caliper. Left. 1963-83 Avanti, 1963-64 Hawk, 1963-66 Lark**\$20.00 ea.**

1558068 Crossover pipe. Right. 1963-64 Hawk, 1963-66 Lark, 1963-83 Avanti.**\$22.00 ea.**

1558069

Crossover pipe. Left. 1963-64 Hawk, 1963-66 Lark, 1963-83 Avanti.**\$22.00 ea.**

PIPE SPACER & CLIPS

194702 Clip, brake pipe to frame. 1939-66 most models.**\$1.95 ea.**



530186 Clip, brake pipe to rear differential.**\$3.90 ea.**

531013 Spacer, brake pipe to rear-end cover.**\$1.50 ea.**

Major Disc Brake Rebuild Kits with Rotors

Kit includes

- 1 new master cylinder
- 4 new front calipers
- 2 front crossover pipes
- 2 front hose to caliper pipes
- 2 front flexible hoses
- 1 rear flexible hose
- 1 copper washer
- 1 set front pads
- 1 set rear shoes (relined)
- (Refundable \$100.00 core charge applies)
- 4 rear shoe return springs (Except late 1971-83 Avanti)
- 2 rear wheel cylinders
- 2 front rotors
- 2 front grease seals
- 2 outer wheel bearings
- 2 inner wheel bearings
- 2 dust caps

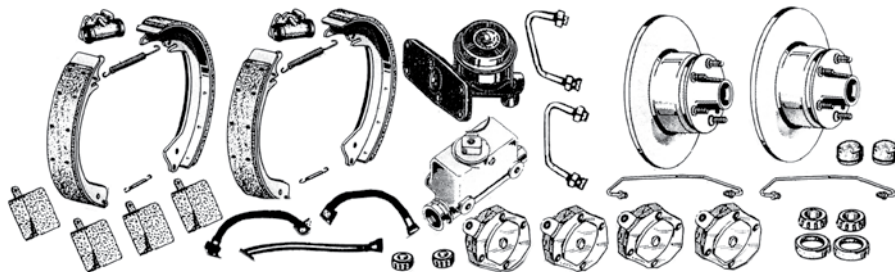

1963-64 HAWK

Total of all parts if purchased separately \$1518.70

Special kit price \$1445.00
—15% QUANTITY DISCOUNT. SEE PAGE 4. ..\$216.75

801559R Your cost \$1228.25/kit

1966 - early 1971 AVANTI

Total of all parts if purchased separately \$1550.70

Special kit price \$1475.00
—15% QUANTITY DISCOUNT. SEE PAGE 4. ..\$221.25

801560R Your cost \$1253.75/kit

1963-66 LARK & 1963-64 AVANTI

Total of all parts if Purchased separately \$1550.70

Special kit price \$1475.00
—15% QUANTITY DISCOUNT. SEE PAGE 4. ..\$221.25

801558R Your cost \$1253.75/kit

Late 1971-83 AVANTI

Total of all parts if purchased separately \$1377.70

Special kit price \$1312.00
—15% QUANTITY DISCOUNT. SEE PAGE 4. ..\$196.80

801561R Your cost \$1115.20/kit

***NOTE: Price does not include core charges. When ordering specify year and model of car.**

No Substitutions or deletions. Core charges are not discountable. Invoice must be included with core for refund.

NEW WHEEL CYLINDERS

197118 1", front. 1939-49 Champion.**\$45.50 ea.**

197120 7/8", rear. 1939-53 Champion & 1951-53 Commander.**\$65.00 ea.**

521570 7/8", rear. 1947-50 Commander. Truck: 2R-2E 5, 6, 7 with self-centering type.**\$89.50 ea.**

525208 1", front. 1950-53 Champion.**\$64.50 ea.**

525821 1" front. 1950-53 Commander. Truck: 2R-2E 5, 6, 7 & 3R-2E 10, 11 with self-energizing.**\$89.25 ea.**

535583 1" front. Car: 1954-66 6-cylinder. Truck: 8E 5, 7.**\$45.50 ea.**

535584 13/16" rear. Car: 1954-66 6-cylinder.**\$45.50 ea.**

535585 1-1/16" front. Car: 1954-66 V-8.**\$49.50 ea.**

535586 7/8" rear. Car: 1954-66 V-8. Truck: 8E 5, 7.**\$45.00 ea.**

681068 Rear. Truck: 2R 14-17 & 3R-E 16, 17, 28, 38 & 3E-6E 16, 28 & 7E-8E 25, 28, 35. Takes 4. All with heavy duty brakes, takes 2 per wheel.**\$63.00 ea.**

683448 Right, rear. Truck: 3R-8E 13, 14, 15.**\$72.25 ea.**

683449 Left, rear. Truck: 3R-8E 13, 14, 15.**\$72.25 ea.**

683450 Right, front. Truck: 3R-8E 13, 14, 15.**\$47.25 ea.**

683451 Left, front. Truck: 3R-8E 13, 14, 15.**\$47.25 ea.**

684606 1" right, front. Truck: 3E-6E 1, 2, 3, 5, 6, 7 & 7E 5, 7.**\$64.50 ea.**

684607 1" left, front. Truck: 3E-6E 1, 2, 3, 5, 6, 7 & 7E 5, 7.**\$64.50 ea.**

Special Disc Brake Rebuild Kit

Kit includes

- 1 new master cylinder
- 4 new front calipers
- 2 front crossover pipes
- 2 front hose to caliper pipes
- 2 front flexible hoses
- 1 rear flexible hose
- 1 copper washer
- 2 front bearing grease seals
- 1 set front pads
- 1 set rear shoes (relined)
- (Refundable \$100.00 core charge applies)
- 4 rear shoe return springs (Except late 1971-83 Avanti)
- 2 rear wheel cylinder

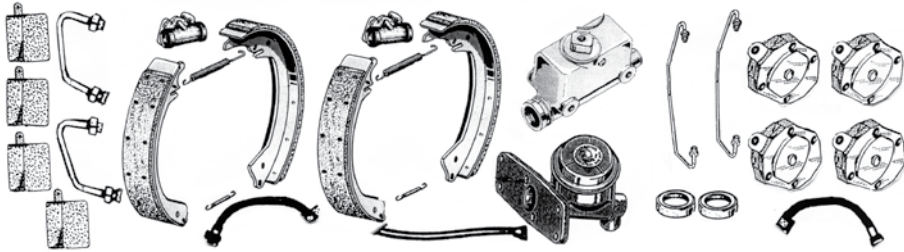

1963-64 HAWK

Total of all parts if purchased separately\$1038.80
 Special kit price \$988.00
 —10% QUANTITY DISCOUNT. SEE PAGE 4. ... \$98.80
801040R Your cost \$889.20/kit

1966 (WITH DUAL MASTER CYLINDER) - early 1971 AVANTI

Total of all parts if purchased separately\$1070.80
 Special kit price \$1018.00
 — 15% QUANTITY DISCOUNT. SEE PAGE 4. ..\$152.70
801063R Your cost \$865.30/kit

1963-66 LARK & 1963-64 AVANTI

Total of all parts if purchased separately\$1070.80
 Special kit price \$1018.00
 —15% QUANTITY DISCOUNT. SEE PAGE 4. ...\$152.70
801039R Your cost \$865.30/kit

Late 1971-83 AVANTI

Total of all parts if purchased separately \$895.80
 Special kit price \$852.00
 — 10% QUANTITY DISCOUNT. SEE PAGE 4. ...\$85.20
801064R Your cost \$766.80/kit

***NOTE: Price does not include core charges. When ordering specify year and model of car.**

No Substitutions or deletions. Core charges are not discountable. Invoice must be included with core for refund.

684608 7/8" rear. Truck: E-2E 5, 6, 7 & 3E-6E 1, 2, 3, 5, 6, 7 & 7E 5, 7 with self-centering type.



.....**\$89.95 ea.**
800340 Right, rear. Late 1971-85 Avanti.**\$22.50 ea.**
800341 Left, rear. Late 1971-83 Avanti.**\$22.50 ea.**
1557668 3/4" rear. 1963-64 Hawk, 1963-66 Lark, 1963-71 Avanti with front disc brakes.**\$89.50 ea.**
1687216 1-1/8" right, rear. Truck: Late 2E & 3E-8E 10, 11, 12.**\$44.50 ea.**
1687217 1-1/8" left, rear. Truck: Late 2E & 3E-8E 10, 11, 12.**\$44.50 ea.**

WHEELS for Trucks

1691040 Dayton wheel, front. Looks like original "extra" option for more money on 1959 (4E) through 1964 (8E) model 40 and 1962 (7E) through 1964 (8E) model 45.**\$227.50 ea.**
1693004 1/2-ton truck wheel 15 X 5.00". Stock on all 1961-64 models. Will bolt up to any 1/2-ton 1941 and later truck.**\$125.00 ea**

NOTE: 1693004 WHEEL WILL ALSO FIT 1940-50 COMMANDER AND LAND CRUISER.

WHEEL CYLINDER PUSH ROD

1552728 1954-66, all models. ... **\$4.50 ea.**



WHEEL CYLINDER REPAIR KITS



S-374 Front. 1939-53 Champion & 1947-53 Commander. Truck: 2R-2E 5, 6, 7, 10, 11, 12 & 3E-7E 1, 2, 3, 5, 6, 7.**\$8.75 ea.**
S-375 Rear. 1939-53 Champion & 1947-53 Commander. Truck: 2R-2E 5, 6, 7 & 3E-7E 1, 2, 3, 5, 6, 7.**\$11.00 ea.**
S-376 Front. 1935-42 Dictator, Commander, President & 1937-39 Coupe Express. Truck: M5.**\$16.00 ea.**
S-377 Rear. 1935-42 Dictator, Commander, President & 1937-39 Coupe Express. Truck: M5.**\$16.00 ea.**
S-387 Front. Truck: M15, 15A, 16, 17 & 2R 14, 15 & 3R-8E 16, 17, 25, 28, 35, 38.**\$15.80 ea.**
S-388 Rear. Truck: M15, 15A, 16, 17 & 2R 14, 15, 16, 17 except heavy duty. ...**\$28.10 ea.**
535556 Front. 1954-66 6-cylinder car. Truck: 8E 5, 7.**\$8.75 ea.**
535557 Rear. 1954-66 6-cylinder car.**\$11.50 ea.**
535558 Front. 1954-66 V-8 car.**\$8.75 ea.**
535559 Rear. 1954-66 V-8 car. Truck: 8E 5, 7.**\$8.75 ea.**
643158 Spring rear wheel cylinder. Truck: 3-R-8E, 13, 14, 15.**\$3.95 ea.**
679048 Rear. Truck: 2R-2E 10, 11, 12 & 3E-6E 2, 3, 6, 7 with 4WD & late 7E 5, 7.**\$11.25 ea.**
681093 Rear. Truck: 2R 14-17 & 3R-8E 16, 17, 25, 28, 35, 38 rebuild kit for 681068 wheel cylinder.**\$19.60 ea.**
683452 Front. Truck: 3R-8E 13, 14, 15 & 3E-4E 11, 12 with 4WD.**\$11.60 ea.**
683453 Rear. Truck: 3R-8E 13, 14, 15.**\$14.25 ea.**
800342 Rear. Late 1971-85 Avanti with front disc brakes.**\$10.50 ea.**
1557671 Rear. 1963-64 Hawk, 1963-66 Lark, 1963-71 Avanti with front disc brakes.**\$11.50 ea.**
1688284 Front. Truck: Late 2E & 3E-8E 10, 11, 12.**\$11.50 ea.**
1693964 Rear. Truck: 3E-8E 10, 11, 12.**\$11.60 ea.**

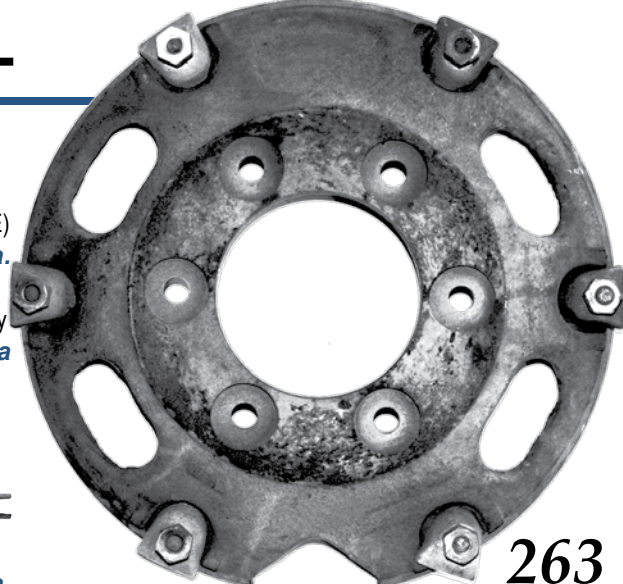

RELINED BRAKE SHOES

- 513421**** 1939-46 Champion front or rear **\$70.00 set**
800179* 1947-50 Commander front or rear & 1951-53 Commander front. Truck: 2R-E 5, 6, 7 front or rear **\$75.00 set**
****800180** 1947-53 Champion front or rear & 1951-53 Commander rear **\$75.00 set**
****800182** 1954-66 6 cyl rear all models. **\$65.00 set**
800317** 1941-42 Commander front or rear. Truck: 1941-48 M5 front & rear. ... **\$70.00 set**
800343* Late 1971-83 Avanti, rear. **\$65.00 set**
1557672* 1963-64 Hawk, 1963-66 Lark, 1963-early 71 Avanti, rear with front disc. Truck: E-2E 5, 6, 7 & 3E-7E 1, 2, 3, 5, 6, 7 front & rear **\$65.00 set**
1560103* 1954-66 V-8 car, all models front. Truck: 8E 5, 7 front & rear. **\$75.00 set**
1560104* 1954-66 V-8 car, all models rear & 1954-66 6-cyl. car front. **\$50.00 set**

Please note: We reserve the right to change core charges and pre-send policies according to the availability of shoes to reline.

NEW BRAKE SHOES

No Cores required.



AVAILABLE
FALL 2014

- 1560103X1** 1954-66 V-8 car, all models front. Truck: 8E 5, 7 front & rear. .. **\$95.00 set**

SHOE RETAINERS

- 185483** Brake shoe retainer. 1934-49 car, 1937-39 Coupe Express, 1941-48 M5 truck and early 2R5 - 2R10 truck. **.95¢ ea.**

- 526531*** Clip. 1950-51 car, all. Truck: Late 2R 5 & 6 through early 2E 5-6-7, late 2R10 -11 through early 2E 10-11-12. Front only. **\$2.25 ea.**



- 535147** Anchor plate. 1954-66, all models. **\$4.50 ea.**

- 535158*** Guide pin. 1954-66 car, all models Truck: 8E 5, 7. **\$1.95 ea.**



- 535159*** Retainer clip. 1954-66 car, all models. Truck: 8E 5, 7. **\$2.50 ea.**

- 642522** "C" clip. 1952-53 Champion & Commander. **\$2.10 ea.**



- 684771** Rear retainer all cars with front disc including 1963 Avanti -1971. Truck: Late 2E-7E **\$3.95 ea.**



- 1559730** Shoe centering block. 1954-66, all models. **\$8.00 ea.**



- 801826**** Truck: 2E-8E 10, 11 12 front and rear. 2E-8E 13,14, 15 Front only. . **\$75.00 set**
***NOTE: A REFUNDABLE CORE CHARGE OF \$100.00 APPLIES TO REMANUFACTURED BRAKE SHOE SETS. (EXCEPT 1560103 - SINCE THEY'RE NEW) INVOICE MUST BE INCLUDED WITH CORE FOR REFUND. BRAKE SHOES COME IN SETS. ONE SET IS ENOUGH TO REPLACE ALL OF THE SHOES ON EITHER THE TWO FRONT OR TWO REAR WHEELS.**

****NOTE: CORE SHORTAGE REQUIRES YOUR OLD SHOES BE RECEIVED PRIOR TO ORDER BEING SENT.**

ALSO NOTE: WE HAVE ASSORTED LININGS, LINING SETS, & SINGLE SHOES AVAILABLE - PLEASE INQUIRE.

NEW MASTER CYLINDERS

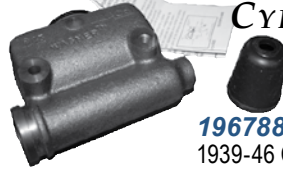

- 196788** 1939-46 Champion. **\$191.65 ea.**

- 199235** 1941-42 Commander & President. Truck: 2R-7E 10, 11, 12. **\$208.00 ea.**
531510 1947-60 car, all models. 1961-64 Hawk. Truck: 2R-3R 5, 6, 7 & E-6E 1, 2, 3, 5, 6, 7 & 7E 5, 7. **\$75.00 ea.**
644751 Truck: M15, 15A, 16, 17. **\$135.00 ea.**

- 681832** Truck: E-6E 17, 38, 40 & 4E-8E 16, 25, 28, 35. **\$239.00 ea.**

- 800277** 1966-early 1971 Avanti w/front disc. **\$148.00 ea.**

- 800278** Late 1971-85 Avanti with front disc. **\$128.50 ea.**

- 1552096** 1961-62 Lark. 1963-64 Lark without split system. **\$132.00 ea.**

- 1557910** 1963-66 Lark & 1963-64 Avanti with front disc. **\$148.00 ea.**

- 1558124** 1963-64 Hawk with front disc. Cap not included. **\$79.00 ea.**

- 1559771** 1963 Lark without power brakes. With split system. Replacement. **\$335.00 ea.**

- 1561611** 1964-66 Lark without power brakes & with split system. Replacement. **\$135.95 ea.**

- 1696852** Truck: 8E 5, 7. **\$124.00 ea.**
1696855 Truck: 8E 10, 12. **\$125.90 ea.**

MASTER CYLINDER FITTINGS & SCREWS

- 189696** Fitting screw. Rear of master cylinder. All models 1953 and later with 531510 master cylinder. Used. **\$20.00 ea.**



- 195470** Master cylinder rear "Y" fitting. 1941-48 M-5, all 1949-56 truck. 1939-64 cars with under floor master cylinder and without hill holder. **\$16.50 ea.**

- 512770** Master cylinder rear fitting. Most models with 531510 master cylinder, one pipe connection. Used. **\$12.50 ea.**



MASTER CYLINDER FILLER PLUG & GASKET



- 196562** Gasket only, master cylinder filler plug. 1940-60 car, all models & 1961-64 Hawk. Truck: M5 & 2R-8E 1-7, 10-45. **\$2.60 ea.**
679927 Filler plug with 196562 gasket. 1940-60 all models & 1961-64 Hawk. Truck: M5 & 2R-8E 1-7, 10-45. 1 5/8" diameter. **\$15.00 ea.**

- NEW Listing - 1559712** gasket, master cylinder lid. 1963-66 Lark with dual master cylinders. **\$5.00 ea.**

- NEW Listing - 1561094** Same as 196562 but with copper. Original equipment on 1963-64 Hawk with disc brakes and will fit all models listed. **\$3.95 ea.**



MASTER CYLINDER & TRANSMISSION HOLE COVER

- 284299** Metal cover. Same application as below. **\$10.00 ea.**

- 292050** Rubber Auto Trans filler cover, 1950-55 most models. Master cylinder cover. 1953-60 car, all models & 1961-64 Hawk, black rubber. **\$19.50 ea.**

MASTER CYLINDER REPAIR KITS

- S-378** 1939-46 Champion



- **\$20.30 ea.**

- S-379** 1935-37 Dictator, 1934-42 Commander & 1935-42 President. Truck: M5 & 2R-6E, 10, 11, 12 & 7E: 10, 12. & 3E-4E 2, 3, 6, 7 with 4WD **\$22.80 ea.**

- S-381** Truck: M15-17 & 2R-6E 13, 14, 16, 17, 28, 38 & 7E 10, 12 with Hydrovac. **\$26.25 ea.**

- 523918** 1947-60 car, all models. 1961-64 Hawk. Truck: 2R-2E: 5, 6, 7 & 3E-7E: 1, 2, 3, 5, 6, 7. **\$26.00 ea.**

- 1553411** 1961-62 Lark (without power assist) **\$21.05 ea.**

- 1558126** 1963-64 Hawk with front disc. **\$26.00 ea.**

- 1558183** 1963-66 Lark & 1963-64 Avanti with front disc. **\$23.00 ea.**

- 1686958** Truck: E-6E 17, 38, 40, 45 & 4E-8E 16, 25, 28, 35 with Hydrovac. **\$35.15 ea.**

- 1696854** Truck: 8E: 5, 7 **\$22.80 ea.**
1696856 Truck: 8E: 10, 12. **\$21.95 ea.**